

Braytron

PRODUCT DATASHEET

MODEL NO BY41-10121

DESCRIPTION BRY-CRC03-48VDC-27.6×52.5-BLC-MAG.RAIL

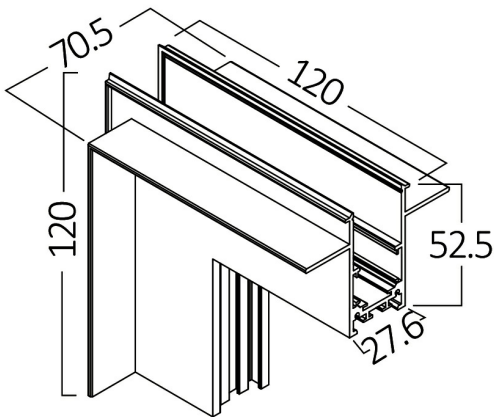
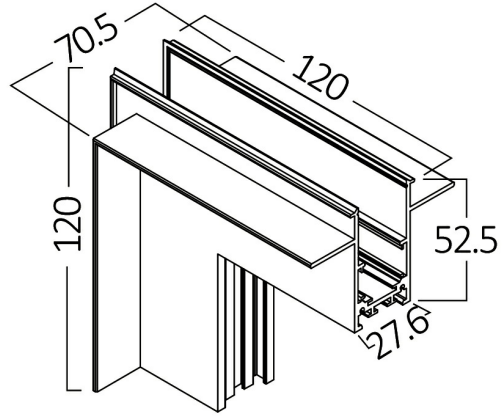

BRAYTRON SRL

Bulavardul Iuliu Maniu, Nr.616, Sector 6, 061129, Bucuresti-ROMANIA

info@braytron.com

www.braytron.com

Page 1-2

General Characteristics

Model No	:	BY41-10121
Main Family	:	Track Lighting
Sub Family	:	Trackrails
Type	:	Mag.Rail
Body Color	:	Black
Lamp Shape	:	N/A
Light Source	:	N/A
Warranty	:	2 years
Class	:	Class III
IP	:	IP20

Dimensions & Weight

P. Length	:	120 mm
P. Width	:	120 mm
P. Height	:	70,5 mm
Weight	:	180 gr

Electrical Characteristics

Voltage	:	48VDC
Material	:	Aluminium
Working Temperature	:	-20 C+40 C

Package Informations

N.W.	:	1,44 kgs
G.W.	:	1,80 kgs
PCS/CTN	:	8 pcs
Length	:	360 mm
Width	:	275 mm
Height	:	150 mm
EAN	:	5949097722790