

PRODUCT DATASHEET

MODEL NO

BY41-00421

DESCRIPTION

BRY-RC01-2M-48VDC-BLC-MAG.RAIL

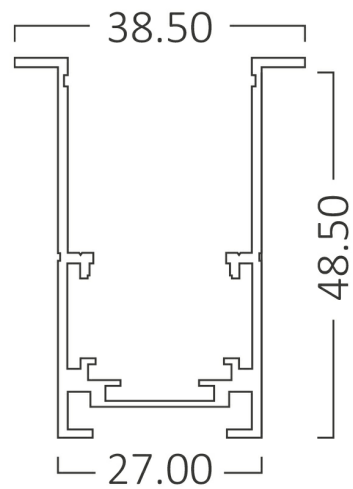
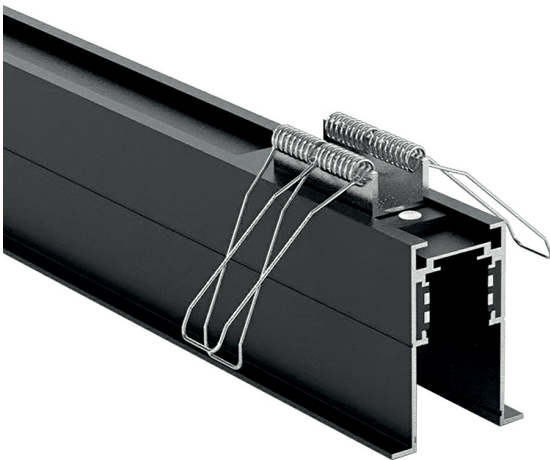
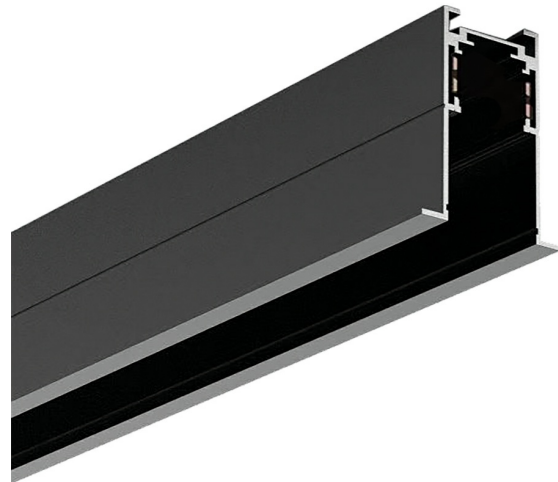
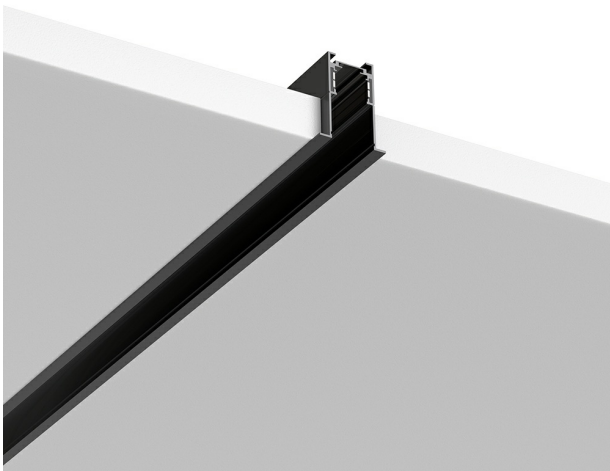

BRAYTRON SRL

Bulaverdul iuliu maniu, Nr.616, Sector 6, 061129, Bucuresti-ROMANIA

info@braytron.com

www.braytron.com

General Characteristics

Model No	:	BY41-00421
Main Family	:	Track Lighting
Sub Family	:	Trackrails
Type	:	Mag.Rail
Body Color	:	Black
Lamp Shape	:	N/A
Light Source	:	N/A
Warranty	:	2 years
Class	:	Class III
IP	:	IP20

Dimensions & Weight

P. Length	:	2000 mm
P. Width	:	38,5 mm
P. Height	:	48,5 mm
Weight	:	1960 gr

Electrical Characteristics

Voltage	:	48VDC
Material	:	Aluminium
Working Temperature	:	-20 C+40 C

Package Informations

N.W.	:	7,84 kgs
G.W.	:	8,20 kgs
PCS/CTN	:	4 pcs
Length	:	2030 mm
Width	:	155 mm
Height	:	55 mm
EAN	:	5949097733093