

PRODUCT DATASHEET

MODEL NO

BV06-00021

DESCRIPTION

BRY-F002T-1H-1xE27-BLC-TABLE LAMP

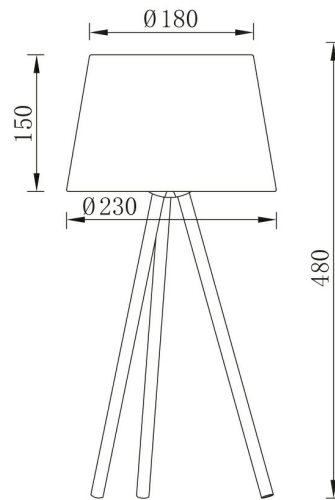

BRAYTRON SRL

Bulaverdul iuliu maniu, Nr.616, Sector 6, 061129, Bucuresti-ROMANIA

info@braytron.com

www.braytron.com

General Characteristics

Model No	:	BV06-00021
Main Family	:	Decorative CLS
Sub Family	:	Floor
Type	:	Table Lamp
Body Color	:	Black
Lamp Shape	:	N/A
Light Source	:	N/A
Socket	:	1xE27
Warranty	:	2 years
Class	:	Class I
IP	:	IP20

Electrical Characteristics

Voltage	:	220-240V
Material	:	Metal+Fabric
Frequency	:	50-60 Hz

Package Informations

N.W.	:	2,32 kgs
G.W.	:	4,00 kgs
PCS/CTN	:	4 pcs
Length	:	560 mm
Width	:	355 mm
Height	:	380 mm
EAN	:	5949097733604

Product Characteristics

Wattage	:	Max 1x23 w
---------	---	------------

Dimensions & Weight

Weight	:	580 gr
--------	---	--------