

Braytron

PRODUCT DATASHEET

MODEL NO

BV06-00020

DESCRIPTION

BRY-F002T-1H-1xE27-WHT-TABLE LAMP

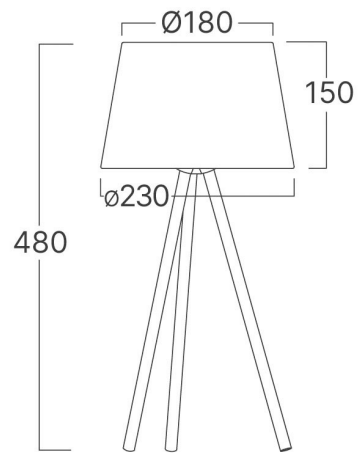

BRAYTRON SRL

Bulavardul iuliu maniu, Nr.616, Sector 6, 061129, Bucuresti-ROMANIA

info@braytron.com

www.braytron.com

Page 1-2

General Characteristics

Model No	:	BV06-00020
Main Family	:	Decorative CLS
Sub Family	:	Floor
Type	:	Table Lamp
Body Color	:	White
Socket	:	E27
Warranty	:	2 Years
Class	:	CLASS I
IP	:	IP20

Electrical Characteristics

Voltage	:	220-240V 50/60Hz
Material	:	Metal-PVC
Working Temperature	:	-20°C ~ +40°C

Package Informations

N.W.	:	2,7 kgs
G.W.	:	4,2 kgs
PCS/CTN	:	4
Length	:	49 cm
Width	:	35,5 cm
Height	:	38 cm
EAN	:	5949097733598

Product Characteristics

Wattage	:	Max.1x23 w
---------	---	------------

Dimensions & Weight

Diameter	:	180 mm
P. Length	:	180 mm
P. Width	:	180 mm
P. Height	:	480 mm
Weight	:	670 gr